

Christmas Bag Tutorial

Supplies Needed:

Printed Fabric, Pre-Washed – dimensions as needed

Cording, Yarn, or Ribbon for drawstring

Safety Pin, Medium Sized

Thread

Rotary Cutter/Scissors

Ruler/measuring Tape

Sewing Machine/Serger

Steps:

Step 1

Lay out your fabric, with right sides together.

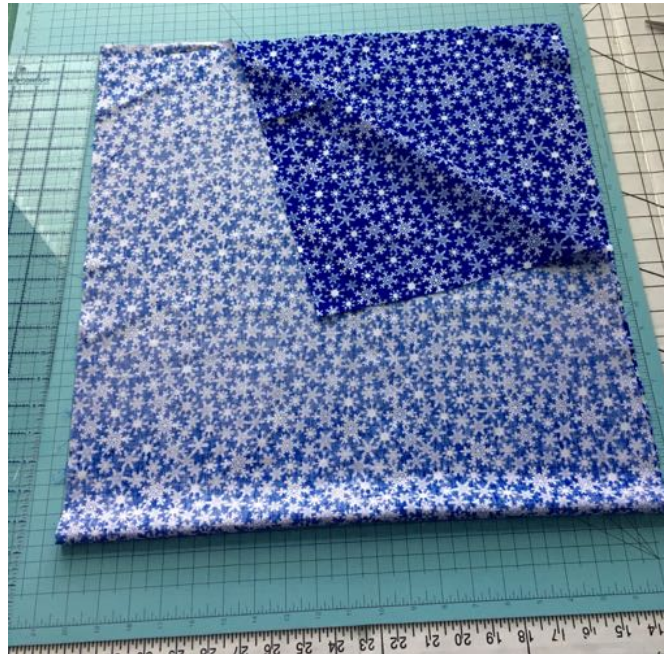

Step 2

Trim uneven sides using a ruler and rotary cutter. (If you don't have one, you need one – it is my new favorite tool!)

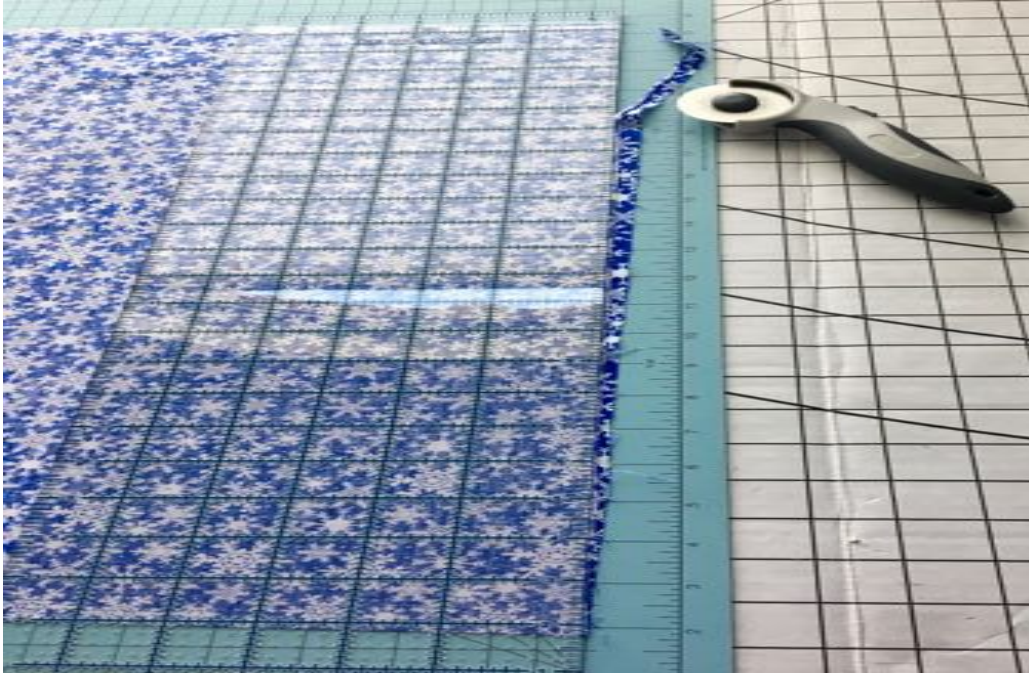

Step 3

Pin sides together to prepare for serging.



Make sure to pin a few inches in to avoid the serger knives.

Step 4

Serge sides together, starting at folded edge and working toward open end.



Finished Edges



Step 5

Iron or serge folded edge, depending on your preference. You will now have a bag shape to work with.



Step 6

To box the bottom, fold with seams lined up, forming a triangle

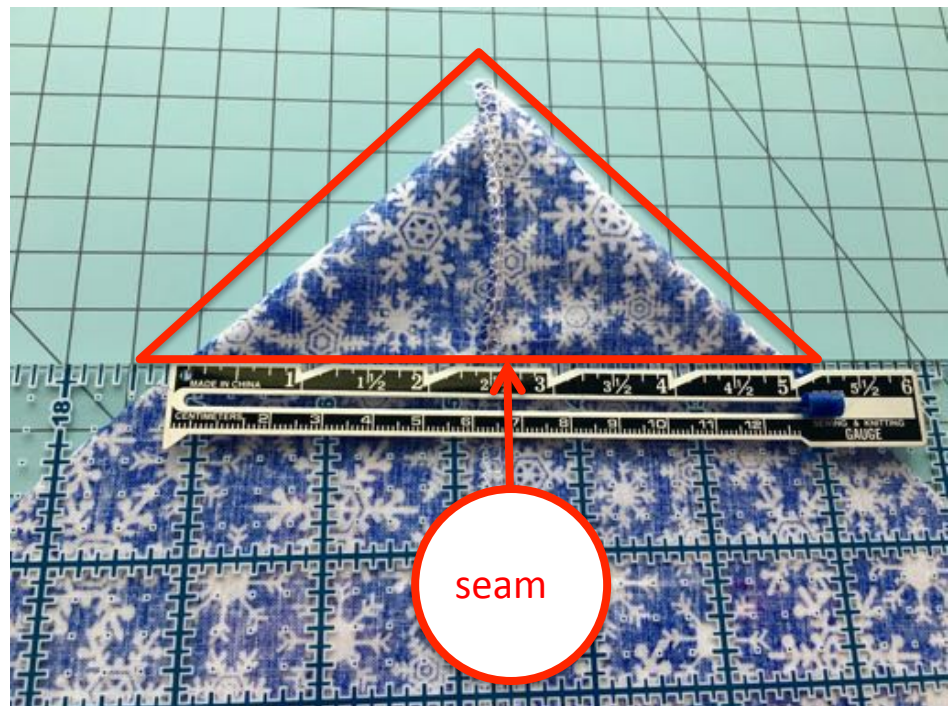

Find more great projects at
Herdingcatshere.com

Step 6 – Cont'd

For this bag, the dimensions are 18" wide by 5" deep, by 20" long. Since I wanted the box to be 5", I moved my ruler until I had 5" and drew my line.

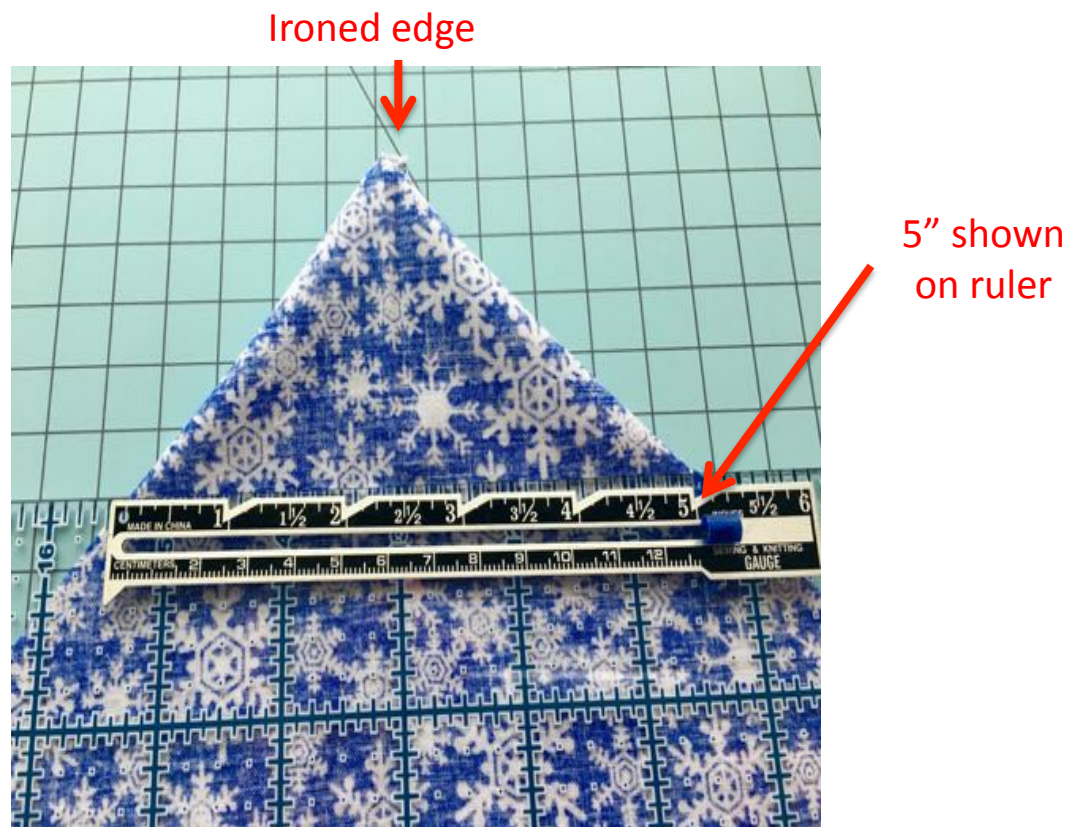
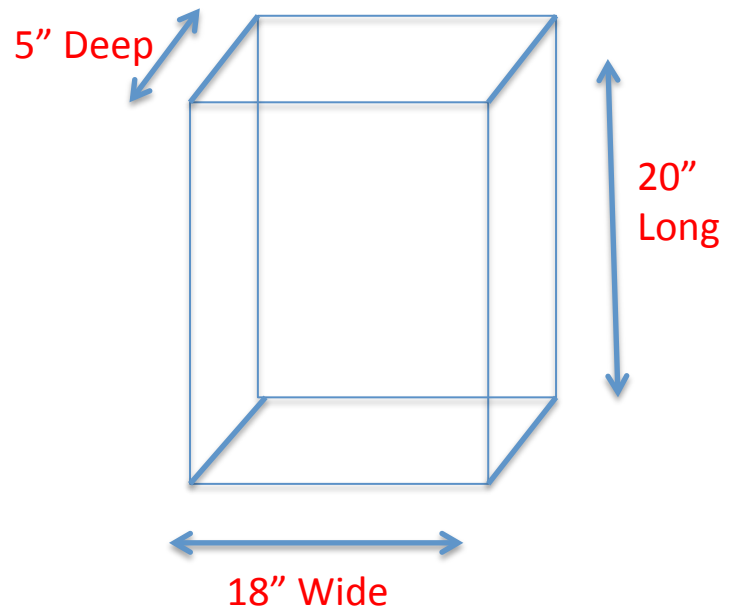

Find more great projects at
Herdingcatshere.com

Step 7

Draw a line using magic marker, and pin together to keep the shape of the box. (You can see in this image, this is the side with the ironed seam. I wanted to show how the pressed seam helps to line up the box.

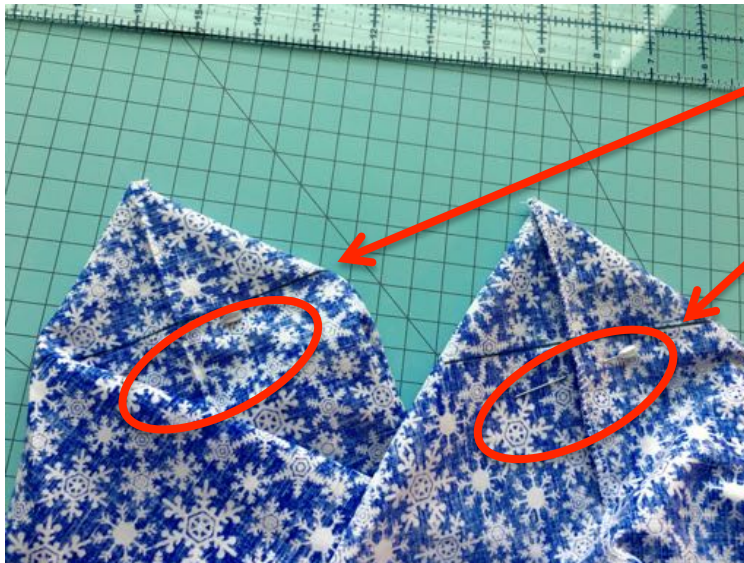
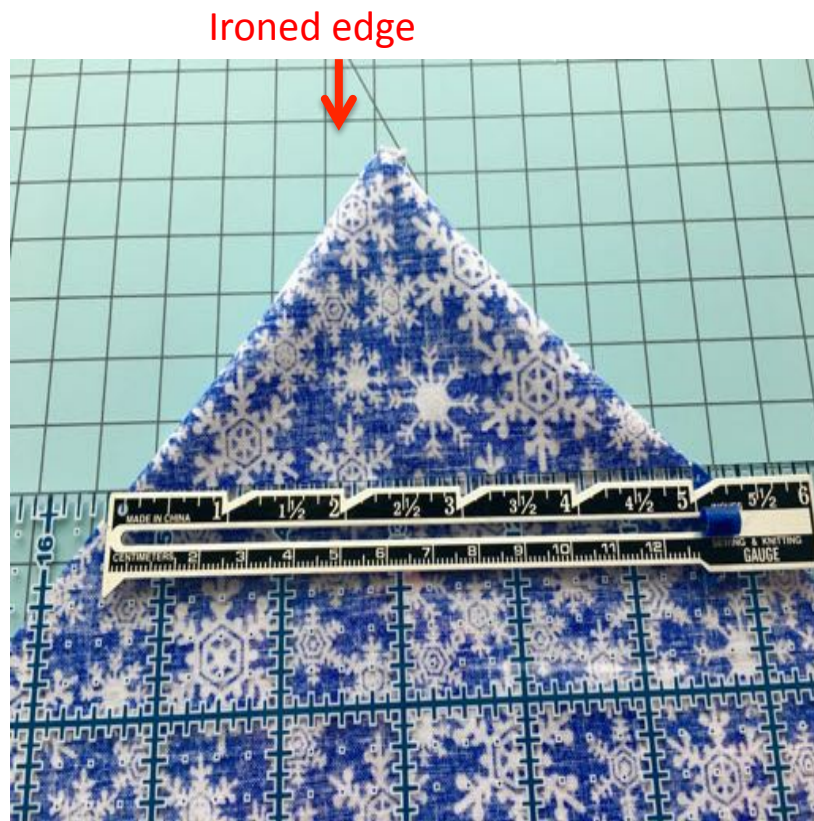

See the black lines and the pins holding the sides together.

Step 8

Serge along the line to finish the seam. (You will end up with two “ears” that can be reused for other projects later, if you want to keep them.)

Serge along black line – the material to the right of the line will be cut off.



Finished Seam



Step 9

Fold the top edge down to form a hem. For this bag, I used a 1/2 " hem, but it can be as wide as you want. You want to make sure the hem will allow enough space for your cording to go through easily.

I used a 1/2 inch hem.

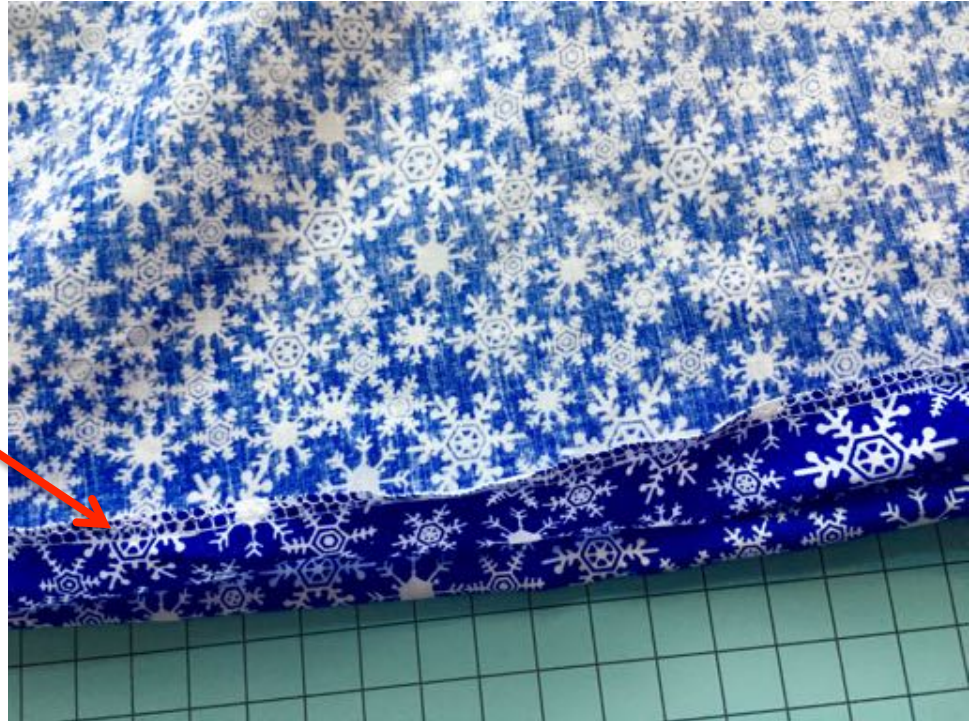

Note: Use A Sewing Machine for the hem.

Step 10

Sew the hem, leaving an opening of about 1 inch to pass the cord through. (I use 2 Pins to mark the opening.)

Pins Marking Start and Stop for Opening to insert Cording



Find more great projects at Herdingcatshere.com

Step 11

Tape the end of the cording before cutting to prevent it from fraying.



Step 12

Place the cording across the bag and add an additional 4-5 inches. (You can see that it is doubled to make sure to have enough to go all around the bag.)



Step 13

Attach a medium sized safety pin to the end of the cording and feed through the opening. Tie a knot in the end.

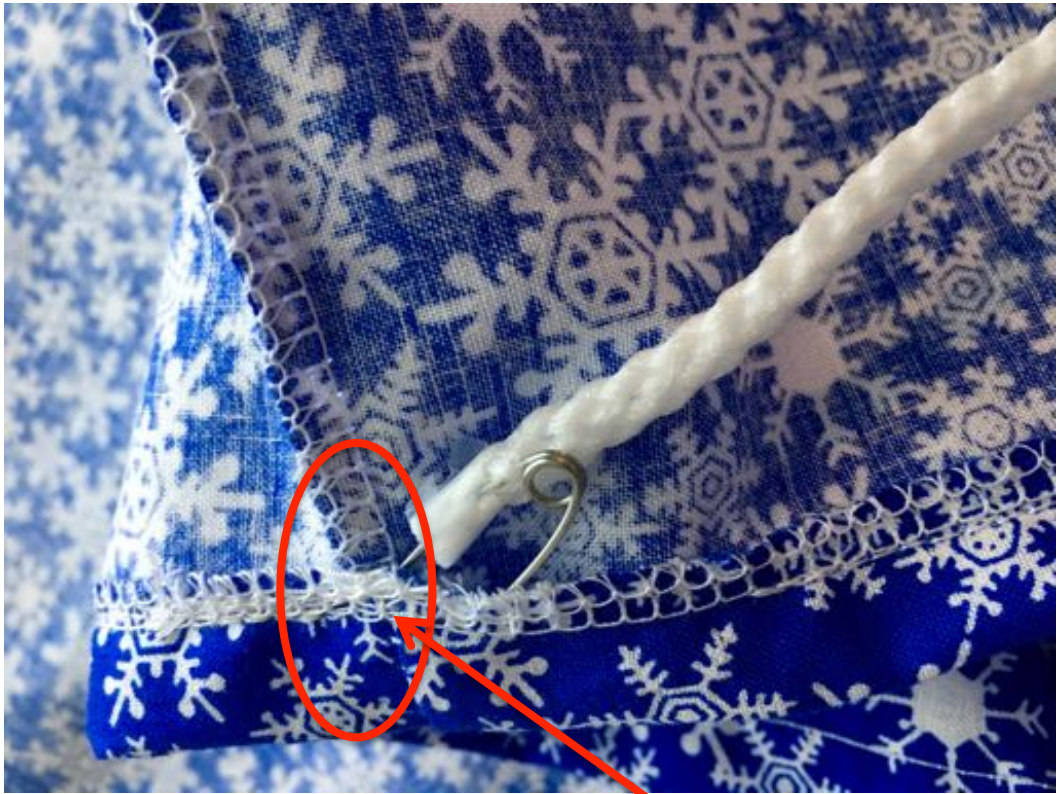

Make sure the seam is facing away when inserting the cording.

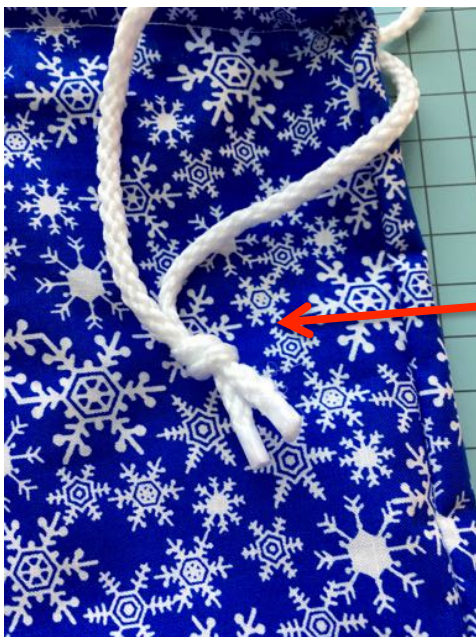

Tie a knot in the end of the cording to keep it from going back into the hem.

Step 14

Place your gift inside, attach a gift tag, and you are finished! Enjoy!
Sherri

